



First in Quality, First in Service.

★ Since ★
1966

Serving
Southwestern
Ontario

e.h.price

AIR DISTRIBUTION PRODUCTS

VOLUME 7



SOUTHWESTERN ONTARIO

LABORATORY

PRODUCT APPLICATION

Supply Venturi Valves

- Medium (0.6 to 3.0 in.w.c.) or low (0.3 to 3.0 in.w.c.) pressure operation
- High-speed actuation
- Characterized and calibrated using NVLAP accredited test stations (Lab Code: 201067-0)
- Operating pressure feedback

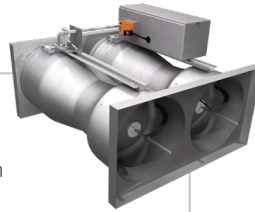

Pace™

- Pressure or volumetric offset control strategies
- Airflow control utilizing Venturi Valves, Venturi FX Valves or Terminal Units
- High speed room level network for communication to Pace and FHC controllers
- BACnet MS/TP



Integrated Reheat Coil

- Factory mounted transition
- Coil access door

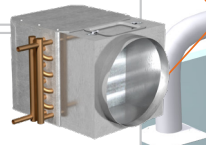

Room Pressure Sensor

- Maintenance and calibration-free sensor technology
- Accurate to 3% of reading
- Designed to prevent buildup of airborne particulates



Thermostat

- LCD or blank-face options
- Optional humidity or CO₂ sensing
- Optional connection to room level network for commissioning

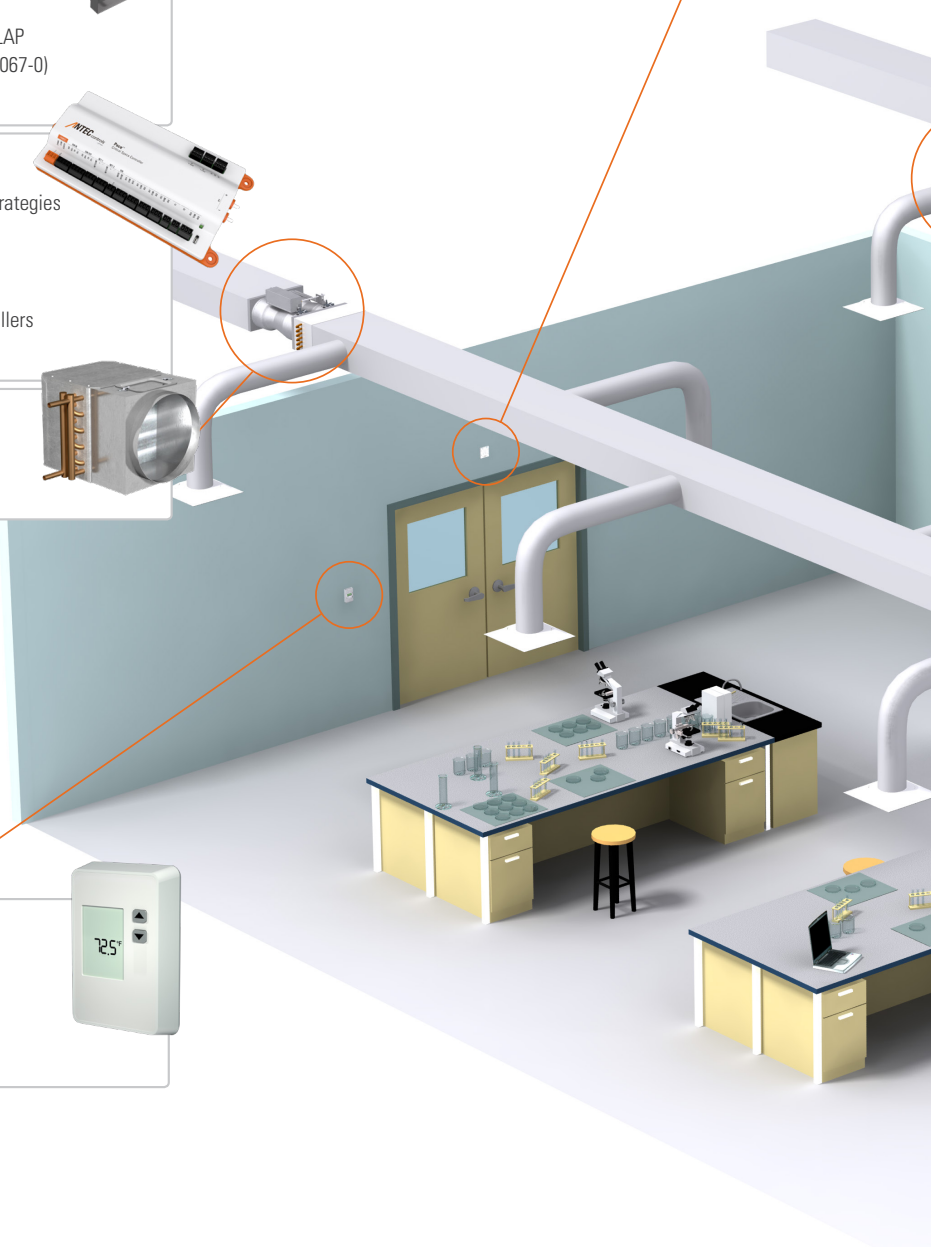

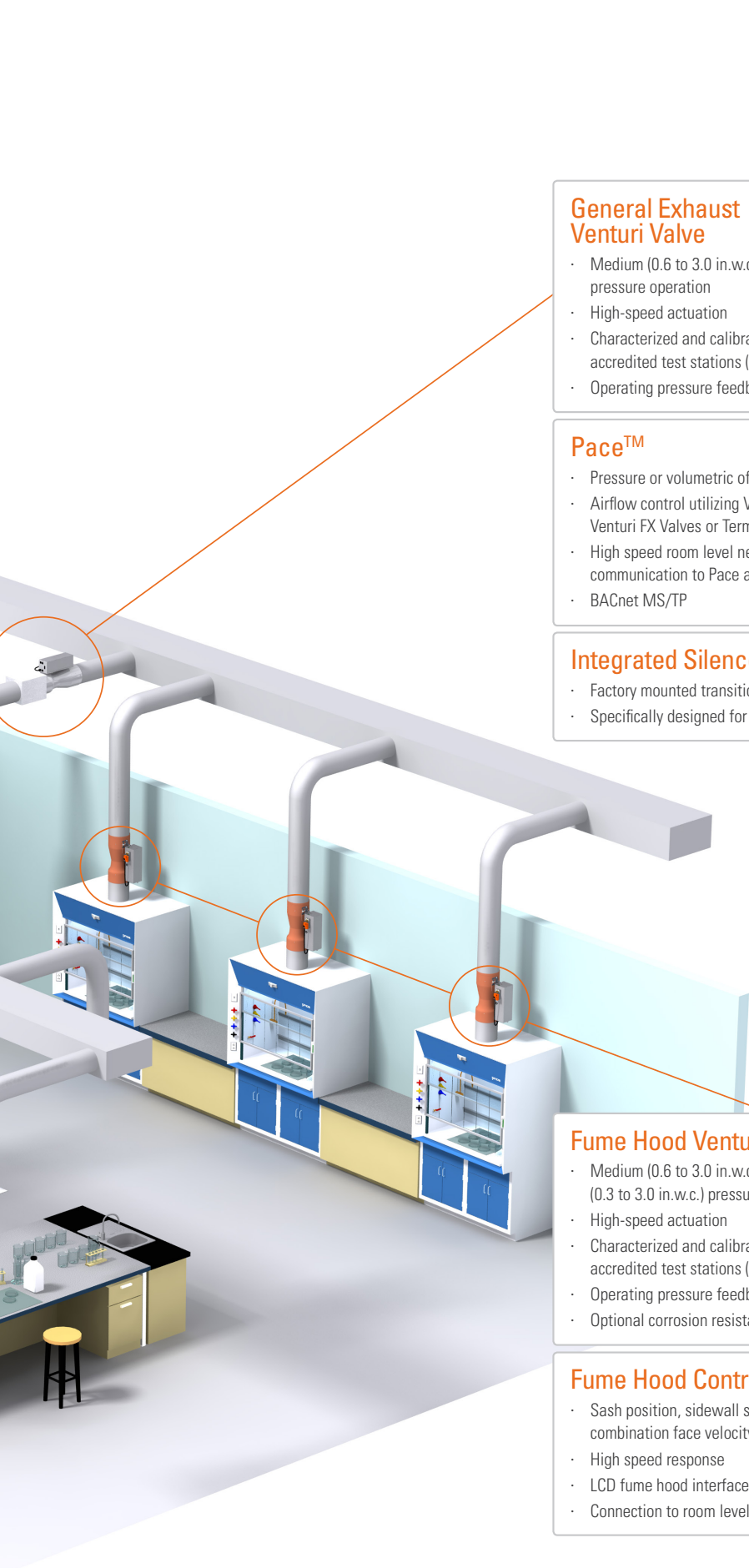

General Exhaust Venturi Valve

- Medium (0.6 to 3.0 in.w.c.) or low (0.3 to 3.0 in.w.c.) pressure operation
- High-speed actuation
- Characterized and calibrated using NVLAP accredited test stations (Lab Code: 201067-0)
- Operating pressure feedback

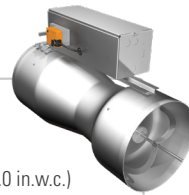

Pace™

- Pressure or volumetric offset control strategies
- Airflow control utilizing Venturi Valves, Venturi FX Valves or Terminal Units
- High speed room level network for communication to Pace and FHC controllers
- BACnet MS/TP



Integrated Silencer

- Factory mounted transition
- Specifically designed for Venturi Valves



Fume Hood Venturi Valve

- Medium (0.6 to 3.0 in.w.c.) or low (0.3 to 3.0 in.w.c.) pressure operation
- High-speed actuation
- Characterized and calibrated using NVLAP accredited test stations (Lab Code: 201067-0)
- Operating pressure feedback
- Optional corrosion resistant coatings

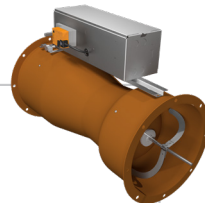

Fume Hood Controller

- Sash position, sidewall sensor or combination face velocity control
- High speed response
- LCD fume hood interface
- Connection to room level network





Above: Chilled Beams

ACTIVE & PASSIVE BEAMS



BUILDING APPLICATIONS

- + Thermal comfort is a major design consideration
- + Spaces with high sensible heat releases
- + Spaces requiring high indoor air quality (100% fresh air)
- + Spaces requiring energy conservation

AIR-WATER SYSTEM BENEFITS

- + Reduced system power consumption
- + Reduced maintenance costs
- + Environmental quality
 - Improved indoor air quality
 - Improved thermal comfort
- + Reduced mechanical footprint

ACTIVE & PASSIVE BEAM TYPES

- + Active linear, vertical, horizontal, modular, perimeter induction units, exposed, and floor mounted cabinets
- + Passive linear beams
- + Passive beams with integrated return

GRILLES, REGISTERS & DIFFUSERS

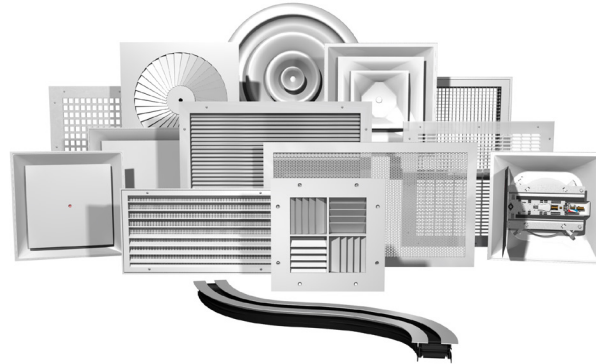

price | GRILLES

Price Industries Limited
www.priceindustries.com

- Grilles and Registers
 - Standard Grilles and Registers
 - Linear Bar Grilles
 - Airfoil Series Grilles and Registers
 - Industrial / Special Application
- Filter Grilles
- Condo Grilles
- Nozzles
- Security Products
- Heavy Duty Gym Grilles



price | DIFFUSERS

Price Industries Limited
www.priceindustries.com

- Linear Diffusers
 - Custom Flow Linear Diffusers
 - Linear Slot Diffusers
- Ceiling Component Diffusers
 - T-Bar Diffusers
 - Light Troffer Diffusers
 - Low Temperature Diffusers
- Ceiling Diffusers
 - Square Ceiling Diffusers
 - Perforated Ceiling Diffusers
 - Square and Rectangular Directional Diffusers
 - Round Cone Diffusers
 - VAV Diffusers



price | DISPLACEMENT

Price Industries Limited
www.priceindustries.com

- Displacement Ventilation
 - Wall Mounted Displacement Diffusers
 - In-Wall Displacement Diffusers
 - Free Standing Displacement Diffusers
- Floor Mounted Displacement Diffusers
- Ceiling Mounted Displacement Diffusers
- Linear Enclosure Displacement Diffusers
- Industrial Displacement Diffusers

price | UNDERFLOOR
MODUFLEX

Price Industries Limited
www.priceindustries.com

- Underfloor Air Distribution
 - Round Floor Diffusers
 - Linear Floor Grilles
 - Linear Floor Heaters
 - Power and Control Modules
- Underfloor Terminal Units
- Underfloor Deflection Grilles
- Vertical Fan Column
- Linear Floor Plenums

GRILLES, REGISTERS & DIFFUSERS CONT'D

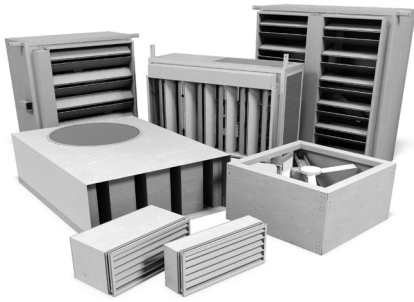

Price Industries Limited
www.priceindustries.com

- Natural Ventilation
 - Natural Ventilation Roof Stack
 - Roof Mounted Natural Ventilation
- Natural Ventilation Terminal
- Wall Mounted Air Transfer Unit



Acutherm
www.acutherm.com

- Square VAV Diffusers
- Round VAV Diffusers
- Linear VAV Diffusers
- Pressure Control Products
- Temperature Control Products



Air Louvers Inc.
www.activarpcg.com/air-louvers

- Fire Rated Door Grilles



Air Concepts Inc.
www.airconceptsinc.com

- Directional Air Distribution Products
- Punnah Diffusers
- Nozzle Diffusers
- Industrial Diffusers



DuctSox
www.ductsox.com

- Fabric Duct Ventilation
- Fabric Faced Diffusers
- Final Filters
- Underfloor Fabric Duct

LOUVERS

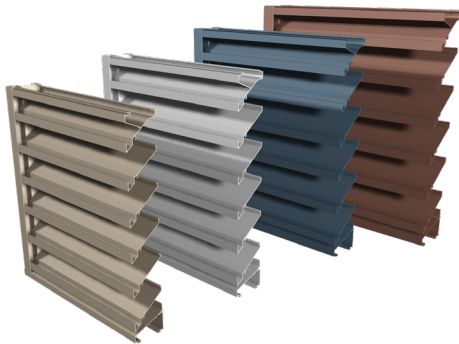

Price Industries Limited
www.priceindustries.com

- Formed Metal Louvers
- Extruded Louvers
- Standard Blade and Chevron Blade Acoustical Louvers
- Extruded Penthouse Louvers
- Formed Metal Penthouse Louvers
- Thinline Wall Application Louvers
- Rain Storm Louvers
- Wind-Driven Rain Louvers
- Sand Louvers
- Vision Screens
- Sightproof Louvers
- Louvered Shapes
- Louvered Doors
- Sunshades
- Equipment Screens
- Architectural Louvers
- Special Louvers as per Request



Greenheck
www.greenheck.com

- Sightproof Extruded Louvers
- Wind-Driven Rain Resistant Extruded Louvers
- Extruded Louvers with Integral Motorized Dampers
- Sand Louvers
- Penthouses and Penthouse Elevator Vents
- Brick Vents
- Equipment Screens



Air Louvers Inc.
www.activarcpg.com/air-louvers

- Door Louvers
 - Fire Rated
 - Non-Vision
 - Lightproof for Darkrooms and X-Ray Rooms
 - Adjustable
- Storm-Proof with Water Baffle
- Severe Windstorm Rated
- Security
- Vision Lites
- Fire-Rated and Impact-Rated Glass



TAMCO
www.tamco.ca

- Premium Quality Aluminum Louvers

DAMPERS



PRICE | DAMPERS

Price Industries Limited
www.priceindustries.com

- Fire Dampers
- Smoke Dampers
- Fire / Smoke Dampers
- Ceiling Radiation Dampers
- Backdraft Dampers
- Control and Balancing Dampers
- Actuators
- Access Doors



TAMCO TAMCO Innovative Damper Products
www.tamco.ca

- Premium Quality:
 - Thermally Insulated / Thermally Broken Frame Control Dampers
 - Aluminum Air-Foil Control Dampers
 - High Quality Aluminum Backdraft Dampers

FANS



GREENHECK
 Building Value in Air.

Greenheck
www.greenheck.com

- Commercial Fans
- Industrial Process Fans
- Gravity Ventilators
- Fiberglass Reinforced Plastic (FRP) Fans for Resistance to Extremely Corrosive Gases / Environments



Canarm/Delhi/Leaderfan
www.canarm.com

- Industrial / Commercial Fans
- Industrial High Performance Ceiling Fans
- Wall Exhaust Fans and Circulating Fans
- Roof Exhausters
- Roof Supply
- Wall Supply / Air Make-Up
- Inline Duct Fan
- Wall Exhausters
- Circulating Fans
- Man Coolers

FANS CONT'D



Fantech
www.fantech.net

- Inline Duct Fans
- Bathroom / Kitchen Exhaust Fans
- Round Backdraft Dampers
- Lint Traps
- Heat Recovery Ventilators



Reversomatic
www.reversomatic.com

- Condominium Fans
- Commercial Fans and Range Hoods



Big Ass Fans
www.bigassfans.com

- Large Fans for Commercial and Industrial Applications
 - Summer Cooling
 - Winter Destratification / Heat Recirculation
 - High Volume, Low Speed Fans 8' to 24' in Diameter



Plastec Ventilation, Inc.
www.plastecvent.net

- Corrosive Resistant Polypropylene Fans and Blowers
- Centrifugal Fans
- Inline Centrifugal Fans
- Stainless Steel Blowers



Envirofan
www.envirofan.com

Banvil 2000
www.banvil2000.com

- Ceiling Destratification Fans
- Industrial Ceiling Fans

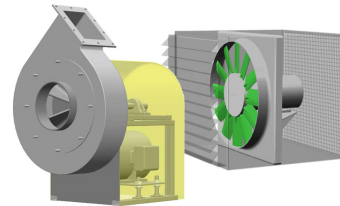

Universal Fan & Blower Ltd.
www.universalfan.com

- Composite FRP / Corrosion Resistant
- Centrifugal and Axial Fans
- Wall Exhaust Fans
- Resistant Ductwork

FANS CONT'D



BROAN

Broan
www.broan.ca

- Kitchen Range Hoods
- Exhaust Fans
- Ventilators



Panasonic

Panasonic
www.panasonic.com/building

- Advanced Ceiling Ventilation Fans
- Fan / Light Combinations
- Through-the-Wall Ventilation Fans
- Super Quiet Inline Fans

AIR FILTRATION - STANDARD & CRITICAL EXHAUST

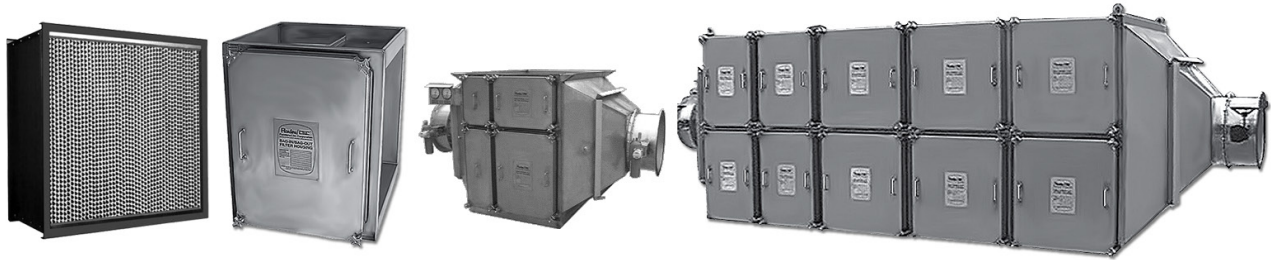

AAF | Flanders

AAF Flanders
www.aafintl.com

- Paint Booth Products
- Air Filter Media and Auto Rolls
- Pleated Filters
- Medium and High Efficiency Rigid Type Air Filters
- Medium and High Efficiency Extended Surface Type Bag Filters
- Metal Washable Air and Grease Filters
- Odor Control Filters
- Carbon Absorbers
- 95% DOP and HEPA / ULPA Filters
- HEPA Housings and Holding Frames
- ASHRAE Side Access Housings and Holding Frames
- Cleanroom Ceiling Filters and Hoods
- Gaseous / Vapor Phase Sideload and Front Load Housings
- CSC Containment Air Filtration Systems (Bag-In / Bag-Out)

LABORATORY, CRITICAL ENVIRONMENT & SPECIALIZED EXHAUST PRODUCTS



Price Industries Limited
www.priceindustries.com

- Ultrasuite O.R. System
- Common Plenum Laminar Array
- Hospital Grade Ceiling Systems
- Air Curtain Systems (HORD System)
- Fan Filter Units
- Laminar Flow Diffusers
- Radial Flow Diffusers
- Return and Exhaust Grilles
- Fume Hoods

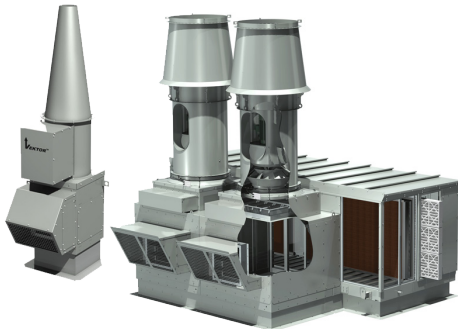

Greenheck
www.greenheck.com

- Vektor Laboratory Exhaust Systems
- Meets ANSI Z9.5, NFPA 45, UL 705 and ASHRAE Chapter 44 Lab Design Guidelines
- Stack Exhaust Fans Designed for 125mph Winds Without Guy Wires
- Minimal Footprint on Roof, Quick and Easy Installation
- Suitable for Constant or Variable Volume Systems Using Bypass Section
- SAVVE Technology – Variable Nozzle Technology to Allow Motor Speed to be Reduced While Maintaining Discharge Velocity



Antec Controls
www.anteccontrols.com

- Valves
 - Venturi Valves – High Turndown Ratio and Mechanical Pressure Independence
 - Venturi FX – Measured Airflow and Low Pressure Operation
 - Integrated Venturi Valve Assembly Options
 - Performance Guaranteed Venturi with Integrated Silencer Assemblies
 - AHRI 410 Certified Venturi with Hot Water Coil Assemblies
 - UL1995 Certified Venturi with Electric Coil Assemblies
- Monitors and Controls
 - Room Monitors
 - Touchscreen Room Pressure Monitor – High Resolution Touchscreen Display
 - Multi-Variable Monitor – High Resolution Touchscreen Displaying up to 8 Rooms on Main Screen
 - All Monitors Have Native BACnet MS/TP Connection
 - Pace™ Critical Space Controller
 - Volumetric Offset or Pressure Control
 - Temperature and Humidity Control
 - Fume Hood Controls
 - Fume Hood Controller
 - Sash Position Sensing Fume Hood Control
 - Sidewall Sensing Fume Hood Control
 - Hybrid Fume Hood Control
 - Presence Sensing
 - Fume Hood Interface

LABORATORY, CRITICAL ENVIRONMENT & SPECIALIZED EXHAUST PRODUCTS CONT'D

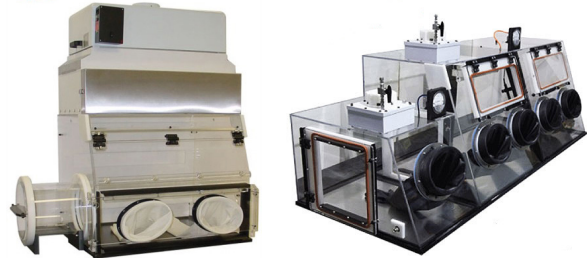
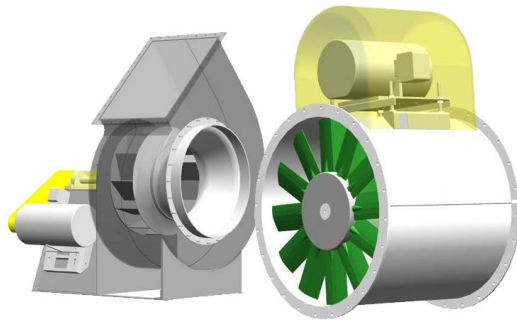

Universal Fan & Blower Ltd.
www.universalfan.com

- Composite FRP / Corrosion Resistant
- Centrifugal and Axial Fans
- Wall Exhaust Fans
- Resistant Ductwork



Flow Sciences
www.flowsciences.com

- Containment Systems for Laboratory, Pilot Plant and Manufacturing Areas
- Specialists in Nanotechnology and Powder Containment
- Dedicated Engineers on Staff to Assist in Custom Equipment



Nederman

Nederman
www.nederman.com

- Fume Extraction Arms and Fans
- Bench Top Flexible Extraction Arms and Fume Cabinets
- Filter Carts and Filter Box Mobile Fume Extractors
- Vehicle Exhaust Fume Extractors and Hose Reels
- Fume Extraction Rail Systems
- Electrostatic and Oil Mist Filters
- Magna Track Fire Station Exhaust Extractors for Rescue Vehicles

GAS DETECTION



Honeywell
 ANALYTICS

Honeywell Analytics
www.honeywellanalytics.com

- Commercial Gas Detection Systems
- Monitors, Controllers and Hand-Held Products

AIR PURIFICATION

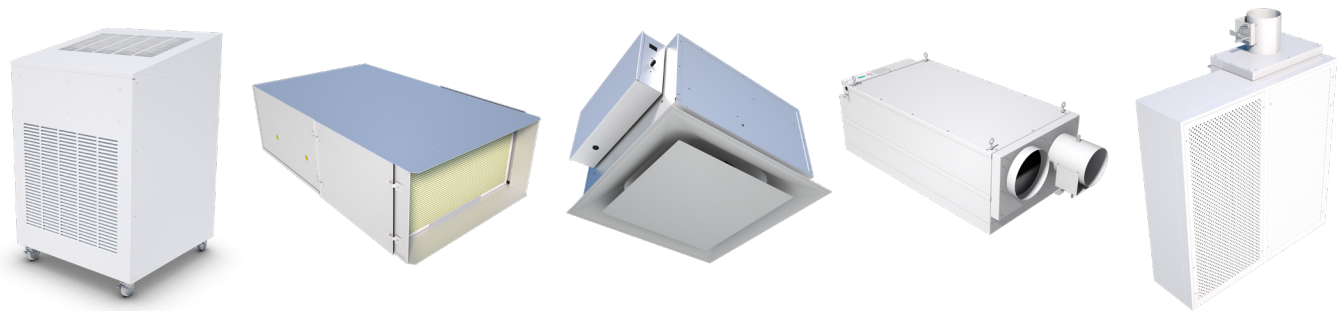

price | AIR PURIFICATION

Price Industries Limited
www.priceindustries.com

RAP: Room Air Purifier

- Rapid purification for high density areas
- UL 2998 and UL 867 certified
- Simple plug and play design
- Optional bipolar ionization and UV light treatment

OAP: Overhead Air Purifier

- Premium installation flexibility
- Quiet air purification solution
- Ceiling mounted design to save valuable floor space
- Optional bipolar ionization and UV light treatment

CAP: Ceiling Air Purifier

- Ceiling concealed with ultra quiet operation
- Motion sensor for maximum efficiency
- Smart Replacement Filter Indicator
- No modifications to existing HVAC system required

PURAFLO: Commercial Fan Filter Unit

- Cleanroom-grade HEPA filtration
- Easy to install with no impact on existing HVAC
- Floor mount for immediate use or ceiling mount for permanent solution
- Dual-outlet reverse flow configuration able to increase air change rate and create negative room pressure

CARES: Critical Area Recirculation/Exhaust Systems

- Part of the Pandemic-Ready Patient Room solution that converts a standard patient room to a negative pressure isolation room at the touch of a button
- Combines a reverse flow Fan Filter Unit (with HEPA) and a one-way, radial diffuser to manage airflow for an entire patient room

ELECTRIC HEATING

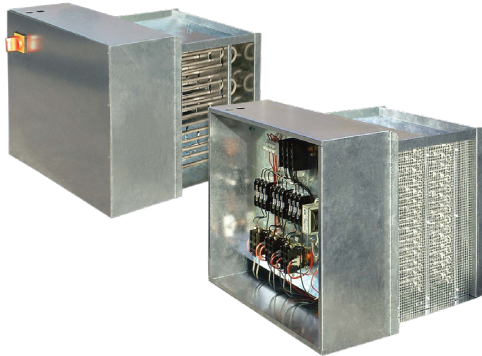

Price Industries Limited
www.priceindustries.com

- Electric Duct Heaters
 - Open or Tubular Coils



Ouellet Electric Heating
www.ouellet.com

- Electrical Heating Products
 - Residential
 - Commercial
 - Industrial
 - Architectural
- Baseboard Heaters
- Unit Heaters
- Portable Heaters
- Draft Barriers
- Wall Heaters
- Diffuser Heaters
- Radiant Heaters
- Cabinet Convector

TERMINAL UNITS



Neptronic
www.neptronic.com

- Electric Heaters



Price Industries Limited
www.priceindustries.com

- Single Duct Terminal Units
- Bypass Controller Type Terminal Unit
- Control Valves
- Dual Duct Terminal Units
- Fan Powered Terminal Units
- Induction Terminal Units
- Retrofit Terminal Units
- Special Application Terminal Units

MAKE-UP AIR UNITS & AIR HANDLERS



SolutionAir
www.solutionairgroup.com



Greenheck
www.greenheck.com

- Air-Cooled DOAS Units
 - Up to 20,000 CFM
 - Heating Options: Gas, Electric, Steam and Hydronic
 - Cooling Options: Hydronic and DX (Packaged or Split)
 - Energy Recovery Options
- Customizable Air Handlers
 - Up to 100,000 CFM
 - Indoor / Outdoor Construction
 - Single / Double Wall Construction
 - Heating Options: Gas, Electric, Steam and Hydronic
 - Cooling Options: Hydronic and DX (Packaged or Split)
 - Energy Recovery
 - Packaged Control
- Make-Up Air Units
 - Direct Fired: 250 – 15,000 MBH
 - Indirect Fired Drum and Tube: 200 – 6,000 MBH
 - Indirect Fired Convolution Tube: 75 – 1,200 MBH
 - 90% Efficient Indirect Fired: 250 – 1,600 MBH
- Rooftop Units (8 – 250 Tons)
 - Highly Configurable
 - Heating Options: Indirect Gas, Electric, Steam and Hydronic
 - Cooling Options: Hydronic and DX (Packaged Up to 160 Tons and Split Up to 250 Tons)
 - Energy Recovery Options

- Direct and Indirect Gas Fired Make-Up Air Units
- Indoor Air Handling Units
- Electric Heating, Hot Water, Chilled Water and DX Options

HVAC DUCTING

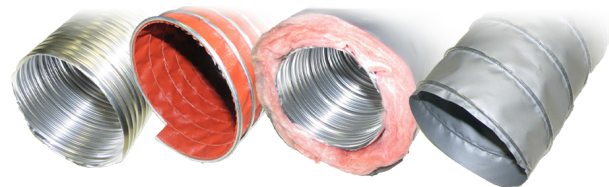

Peppertree Air Solutions
www.peppertreeairsolutions.com

- Flexible HVAC Ducting

KITCHEN VENTILATION SYSTEMS



Greenheck
www.greenheck.com

- Wall, Island Proximity and Heat, Condensate Hoods
- Internal and External Supply Plenums Optional
- Standard Baffle Filter, High Velocity Cartridge, High Efficiency Grease-X-Tractor and Dual Stage Grease Grabber, Filtration
- FlexConnect Utility Distribution System
 - Factory Built Wall Utility Systems Offering Single Point Connections for Gas, Water and Electricity
- Easy to Clean Stainless Steel Exterior
- Adds Flexibility, Easy Relocation of Equipment, Reduces Installation Time, Allows Integration of Controls and Concealment of All Pipes and Wiring

AIR CURTAINS



Biddle Climate Solutions
www.biddle.ca

- Commercial, Retail and Industrial Air Curtains
- NOZ Adjustable Nozzle Unit Heater for High Induction

FAN COILS & HYDRONIC HEATING AND COOLING

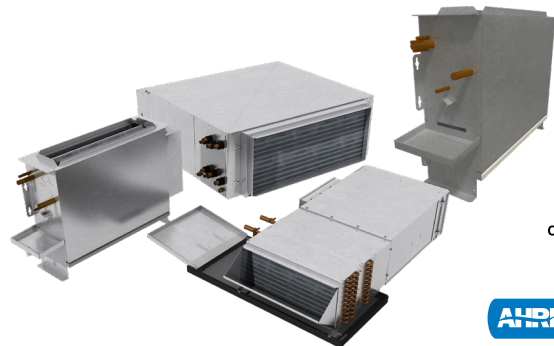

Price Industries Limited
www.priceindustries.com

- Chilled Beams
 - Linear, Modular, Horizontal, Vertical and Floor-Mounted Active
 - Linear Passive
- Passive with Integrated Returns
- Controls and Hose Kits
- Retrofit Perimeter Induction Units



Price Industries Limited
www.priceindustries.com

- High Performance Fan Coils
 - Optional Integrated Silencer
 - Standard ECM Motor
- Horizontal Blower Coils
- Vertical Fan Coils
 - Concealed and Exposed

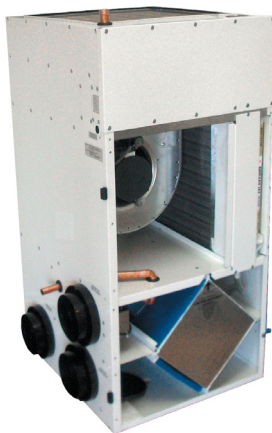

HEAT & ENERGY RECOVERY



Nu-Air Ventilation
www.nu-airventilation.com

- Enerboss Integrated Air Handlers and Fan Coils with Optional Integral HRV



SolutionAir
www.solutionairgroup.com

- RegenCore Alternating Mass-Exchanger Energy Recovery Units
 - No Pre-Heat Requirements Down to Outdoor Temperatures of -40°C
 - Up to 92% Effectiveness

HEAT & ENERGY RECOVERY CONT'D

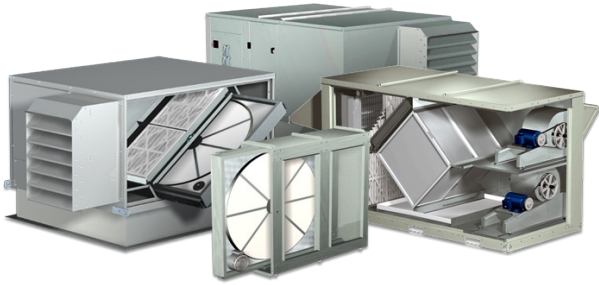

Greenheck
www.greenheck.com

- Minivent Interior ERV
- PVE Plate Heat Exchanger
- ERV and ERVE Energy Recovery Units
- RVE Packaged Air Handler with Integral Energy Recovery

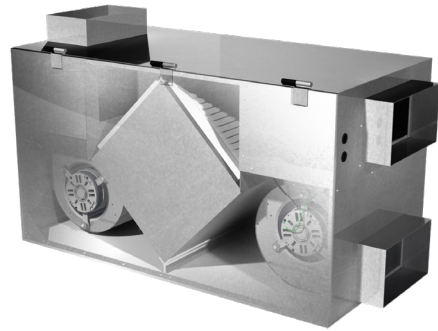

Nu-Air Ventilation
www.nu-airventilation.com

- Residential HRVs and ERVs
- Commercial HRVs and ERVs
- Enerboss Integrated Air Handlers and Fan Coils
- Air Exchangers, Passive HRVs and Wet Basement Solutions
- Controls and Accessories

NOISE CONTROL & VIBRATION ISOLATION

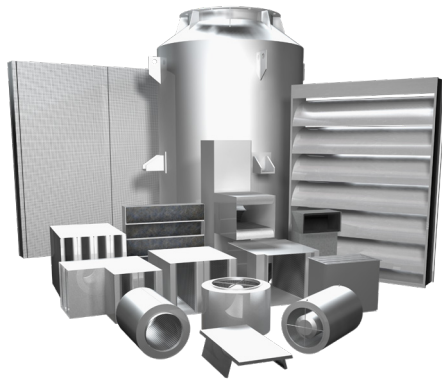

Price Industries Limited
www.priceindustries.com

- Commercial and Custom Silencers
- Rectangular, Elbow and Circular Silencers
- Absorptive, Film-Lined and Packless Silencers
- Air Transfer and Cross-Talk Silencers
- Acoustic Panels, Enclosures and Barriers
- Acoustical Louvers
- SMWIA-L30 Yellow Label Manufacturing



The VMC Group
www.thevmcgroup.com

- Seismic Sway Bracing and Rod Stiffening Products
- Floor Mounted Seismically Restrained Isolators
- Seismic / Vibration Isolating Roof Curbs
- Spring Hangers
- Inertia Bases and Rails
- Flexible Connectors
- Piping Specialties
- Pad-Type Isolators

CONTROLS



price | CONTROLS

Price Industries Limited
www.priceindustries.com

- Application Specific Controls For:
 - Networked or Stand-Alone Applications
 - VAV / VVT Controllers (BTL Certified)
 - Mini-Front-End Solutions
- Pneumatic Stand-Alone Controls

- Control Applications:
 - Rooftop Controls
 - Bypass Controls
 - Single Duct Controls
 - Fan Powered Controls
 - Prodigy Smart Diffusers
 - Web Server Graphical Interface
 - Hydronic Controls
 - Underfloor Controls



Franklin Control Systems
www.franklin-controls.com

- HVAC Specialty Products
 - Building Automation Starters
 - Standard Automation Starters
 - Cooling Tower Controls
 - Kitchen Hood Controls
 - Pump and HVAC Controls
 - Variable Frequency Drives (VFD)

- Industrial Products
 - Contactors and Overload Relays
 - Manual Motor Starters
 - Circuit Breakers
 - Starters
 - Soft Starters
 - Soft Starters with Integrated Bypass
 - Programmable Logic Controllers
 - Terminal Blocks
 - Pilot-Devices
 - Enclosures



NEMA Rated  



SMART STARTERS AND VFDs

Advanced Across the Line Solutions for HVAC Applications

HVAC Specialty Products

- Building Automation Starters
- Standard Automation Starters
- Cooling Tower Controls
- Kitchen Hood Controls
- Pump & HVAC Controls



NEMA Rated  



Industrial Products

- Contactors and Overload Relays
- Manual Motor Starters
- Circuit Breakers
- Starters
- Soft Starters
- Soft Starters with Integrated Bypass
- Programmable Logic Controllers
- Terminal Blocks
- Pilot-Devices
- Enclosures



www.franklin-controls.com



Creating Safe & Clean Work Environments

- Fume Extraction Arms and Fans
- Bench Top Flexible Extraction Arms and Fume Cabinets
- Filter Carts & Filter Box Mobile Fume Extractors
- Vehicle Exhaust Fume Extractors and Hose Reels
- Fume Extraction Rail Systems
- Electrostatic & Oil Mist Filters
- Magna Track Fire Station Exhaust Extractors For Rescue Vehicles

Nederman

www.nederman.com



First in Quality, First in Service

www.ehpricesouthwesternontario.com

LOCATIONS SERVICING SOUTHWESTERN ONTARIO

CAMBRIDGE

Unit 8-75 Saltsman Drive
Cambridge, ON, Canada N3H 4R7
Ph: 519.653.9470
Fax: 519.653.7853
cambridge@ehpricesales.com

LONDON

Unit 6-2351 Huron Street
London, ON, Canada N5V 3K4
Ph: 519.451.5100
Fax: 519.451.8726
london@ehpricesales.com

Local Delivery Available • Contact your E.H. Price Sales Representative for more information

.....

HAMILTON

70 Unsworth Drive
Unit #11
Hamilton, Ontario
L8W 3K4
Ph: 905.383.3599
Fax: 905.383.1274
hamilton@ehpricesales.com
www.ehpricehamilton.com

TORONTO

571 Chrislea Road
Unit #3
Woodbridge, Ontario
L4L 8A2
Ph: 905.669.8988
Fax: 905.669.8023
toronto@ehpricesales.com
www.ehpricetoronto.com

OSHAWA

500 Wentworth Street East
Unit #12
Oshawa, Ontario
L1H 3V9
Ph: 905.669.8988
Fax: 905.669.8023
oshawa@ehpricesales.com
www.ehpriceoshawa.com

OTTAWA

3236 Hawthorne Road
Ottawa, Ontario
K1G 3W9
Ph: 613.725.2029
ottawa@ehpricesales.com
www.ehpriceottawa.com

SUB REP - SUDBURY & N.E. ONTARIO

Jack Dougan Associates
74 Mumford Drive
Lively, Ontario
P3Y 1H9
Ph: 705.692.5838
Fax: 705.692.5685
tim@jdaltd.ca
www.jdaltd.ca

SUB REP - WINDSOR

LK Metal Products Co. Limited
1595 Lincoln Road
Windsor, Ontario
N8Y 2J3
Ph: 519.256.1861
Fax: 519.256.2828
mail@lkmatal.com
www.lkmatal.com